

# MONTANA

Serie semirotondă cu barieră termică

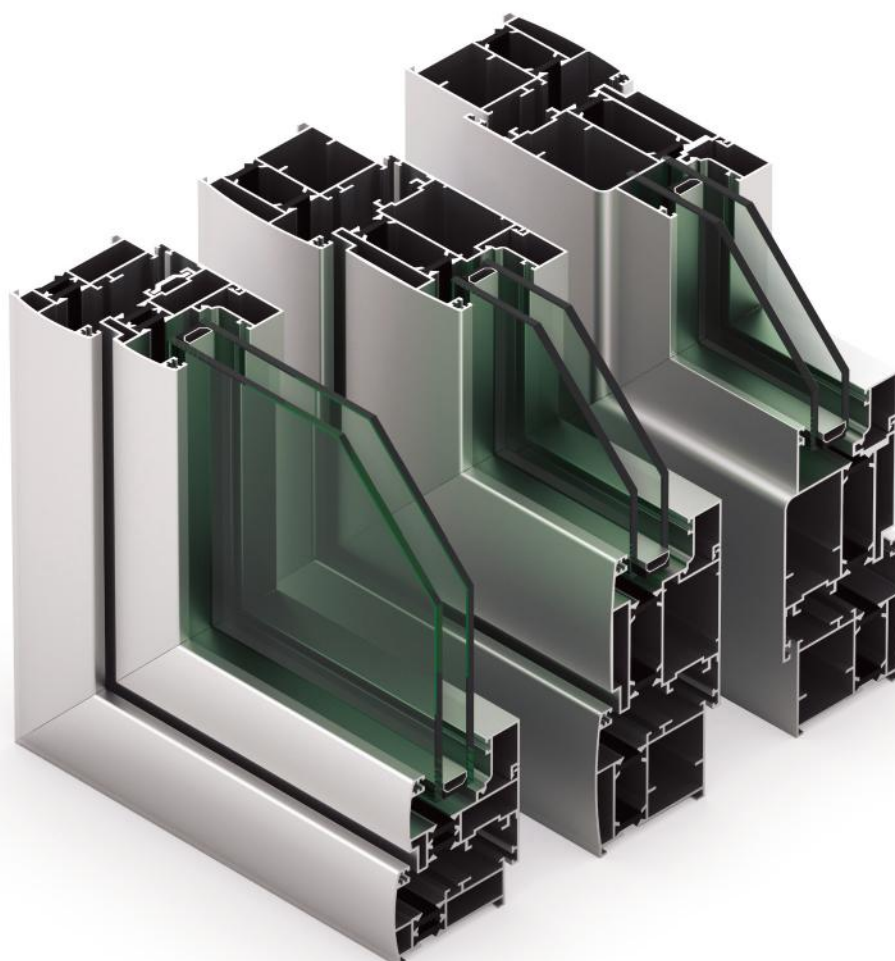



stejar auriu



nuc lacuit



wenge

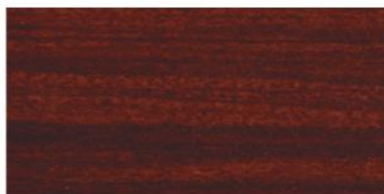

mahon



nuc renolit



stejar deschis m



stejar deschis d



stejar deschis rustic



nuc



nuc inchis



nuc rustic



nuc mat



fag



RAL 7016



RAL 8003

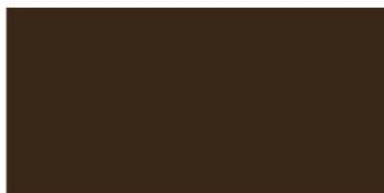

RAL 8014



RAL 8019



RAL 9005



RAL 9006



RAL 9016

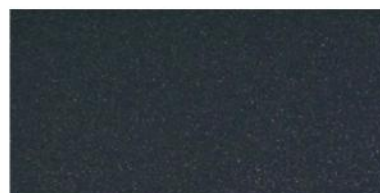

antracit



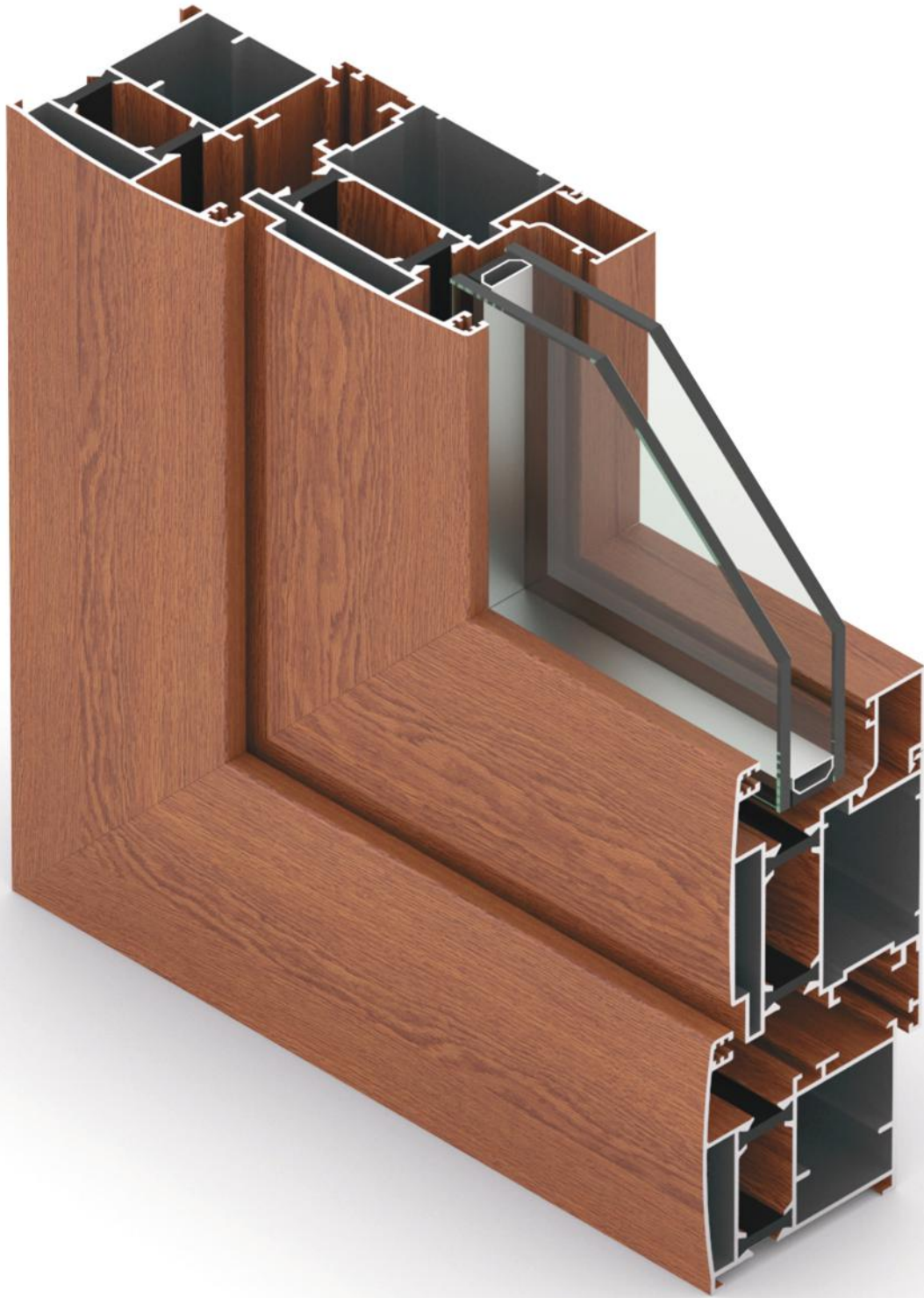

# MONTANA - SERIE SEMIROTUNDA, CU BARIERA TERMICA

## Sectiuni profile

COD 2.11 G=0.94 kg/m P=344 mm  
Toc mic

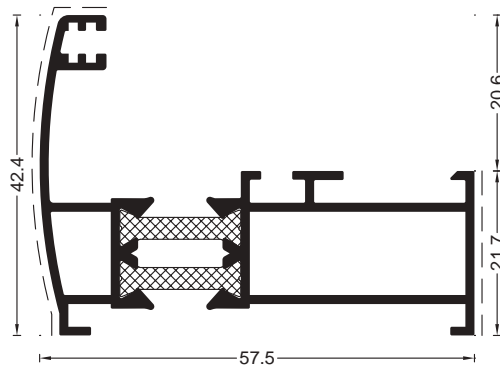

COD 2.17 G=1.09 kg/m P=428 mm  
Toc mediu

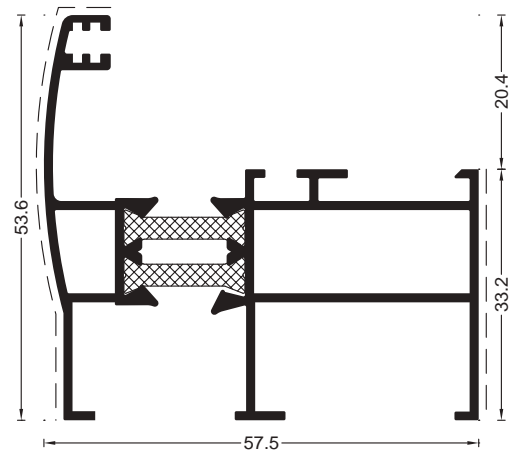

COD 2.14 G=1.34 kg/m P=532 mm  
Toc mare

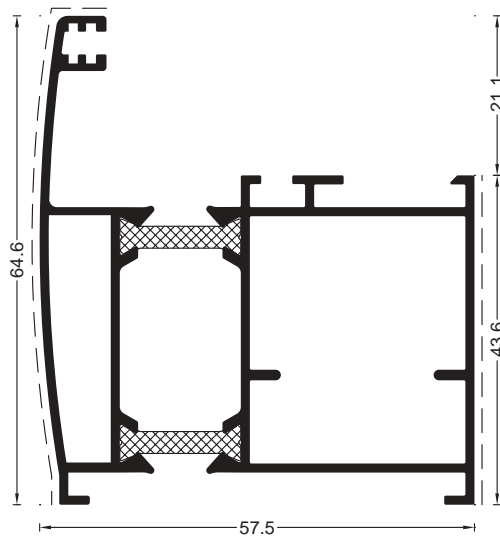

COD 2.13 G=1.07 kg/m P=396 mm  
Montant - traversa mica

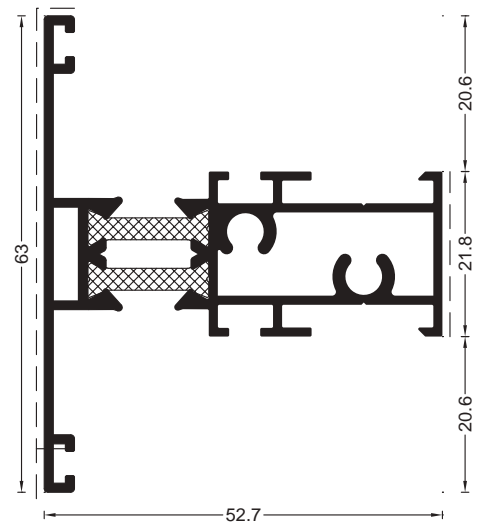

COD 2.9 G=1.40 kg/m P=483 mm  
Montant - traversa mare

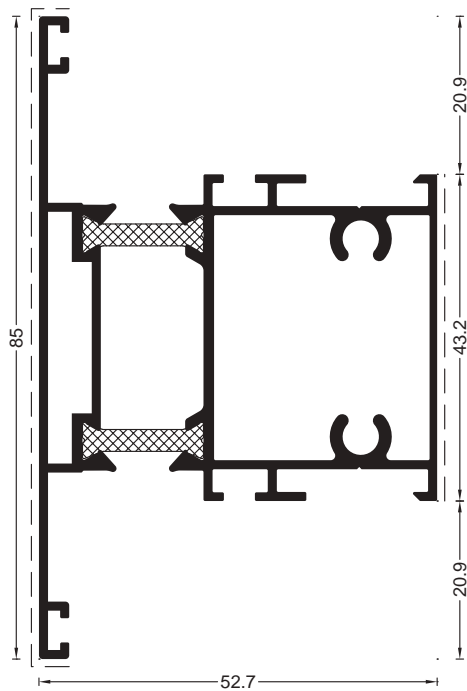

COD 2.12 G=1.06 kg/m P=408 mm  
Cercevea mica

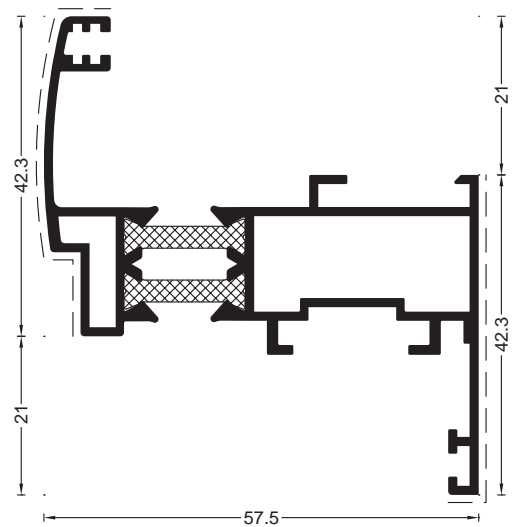

# MONTANA - SERIE SEMIROTUNDA, CU BARIERA TERMICA

## Sectiuni profile

COD 2.21 G=1.48 kg/m P=515 mm  
Ceravea mare

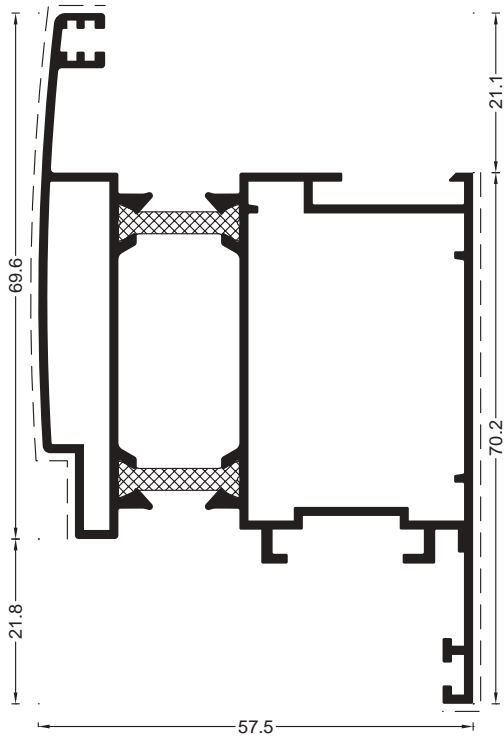

COD 2.10 G=1.67 kg/m P=532 mm  
Ceravea deschidere exteriora

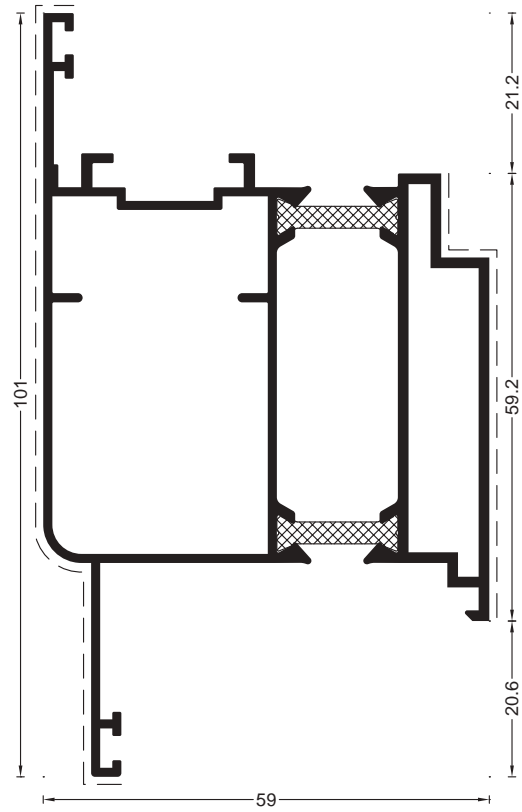

COD 2.16 G=1.18 kg/m P=348 mm  
Inversor

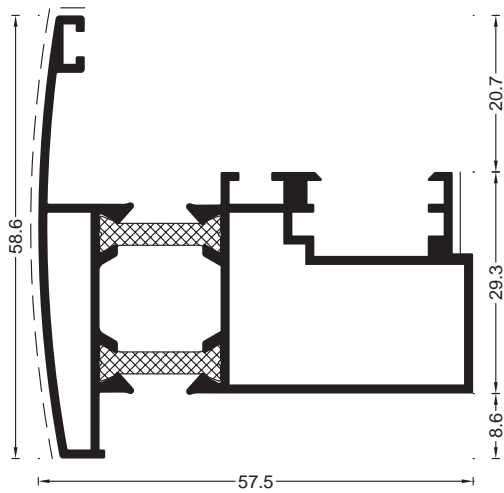

COD 2.18 G=1.24 kg/m P=324 mm  
Adaptor 90°

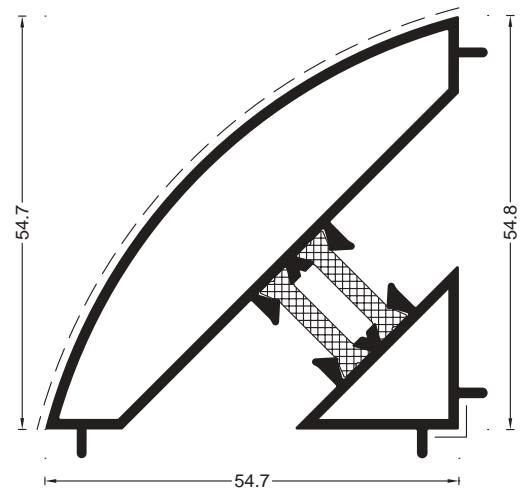

# MONTANA - SERIE SEMIROTUNDA, CU BARIERA TERMICA

## Sectiuni profile

COD 2.15 G=0.13 kg/m P=217 mm  
Clips aditional

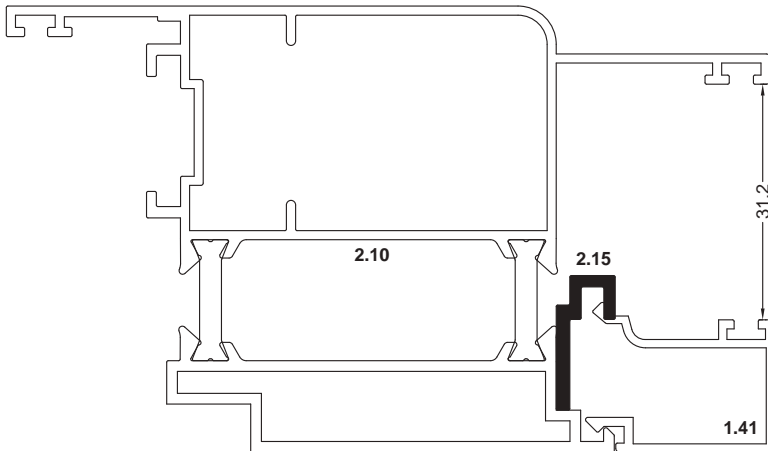

COD 1.42 G=0.18 kg/m P=94 mm  
Picurator

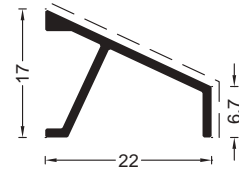

COD 1.22 G=0.13 kg/m P=65 mm  
Conector panouri

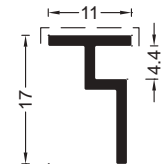

COD 1.13 G=0.71 kg/m P=210 mm  
Lambriu

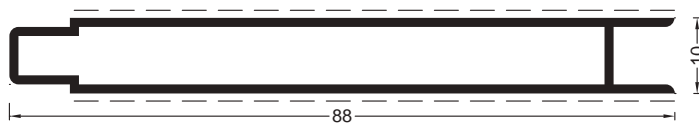

COD 1.38 G=0.11 kg/m P=46 mm  
Tija cremon

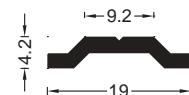

COD 1.36 G=0.25kg/m P=159 mm  
Bagheta 21,7mm

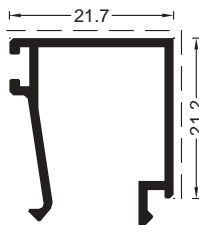

COD 1.41 G=0.24 kg/m P=154 mm  
Bagheta 17,5mm

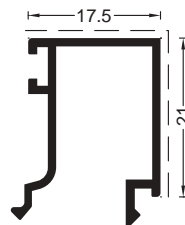

COD 1.37 G=0.22 kg/m P=120 mm  
Bagheta 5,2mm

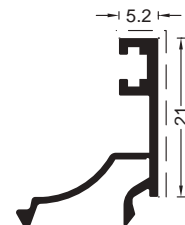

## Tipuri de vitrare

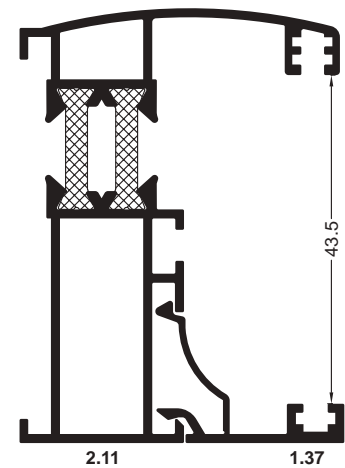
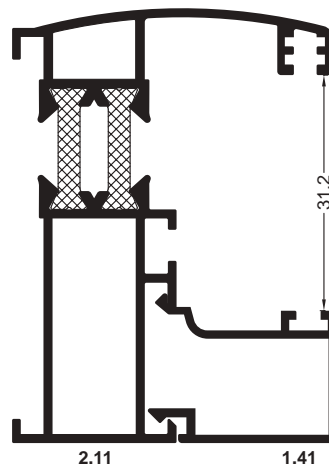
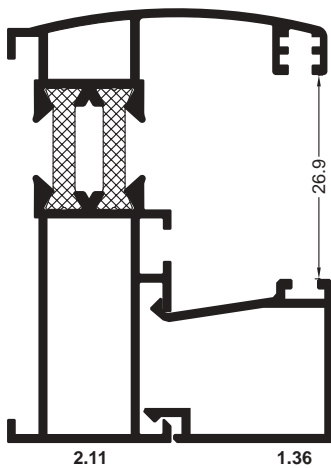

# MONTANA - SERIE SEMIROTUNDA, CU BARIERA TERMICA

## Sectiuni caracteristice pentru ferestre si usi

Fereastră cu 1 canat batant / oscilo-batant.

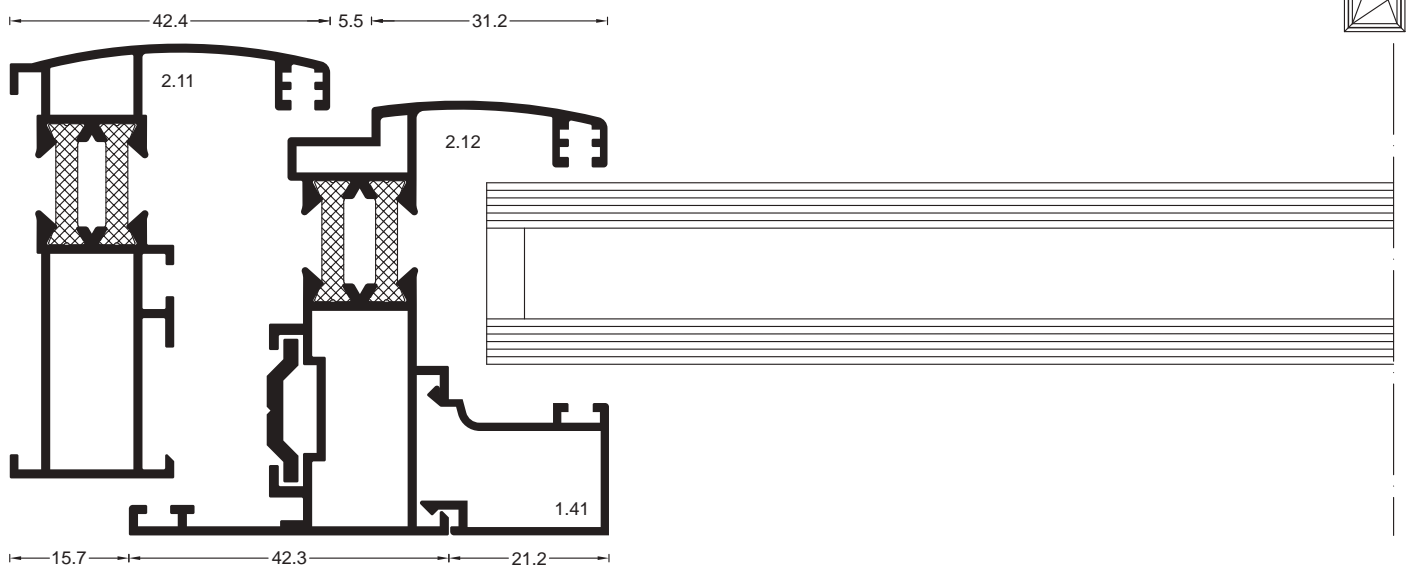

Fereastră 2 canate cu inversor, un cant batant si unul batant / oscilo batant.

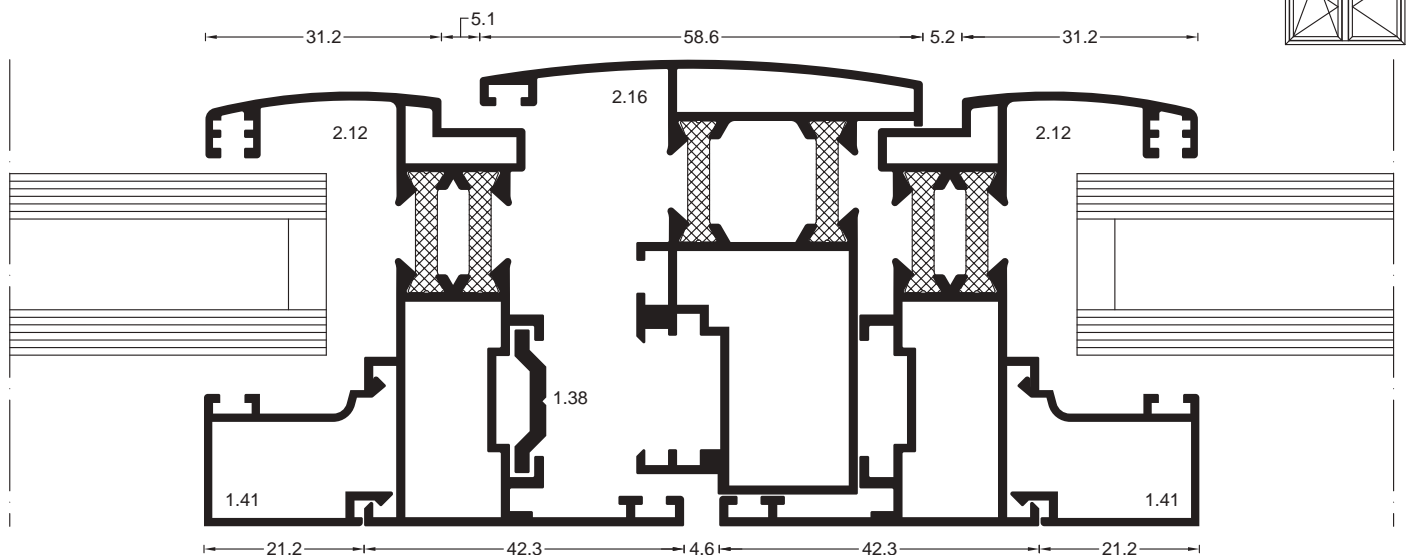

Exemplu de cuplare dintre o fereastră și o ușă-fereastră de balcon.

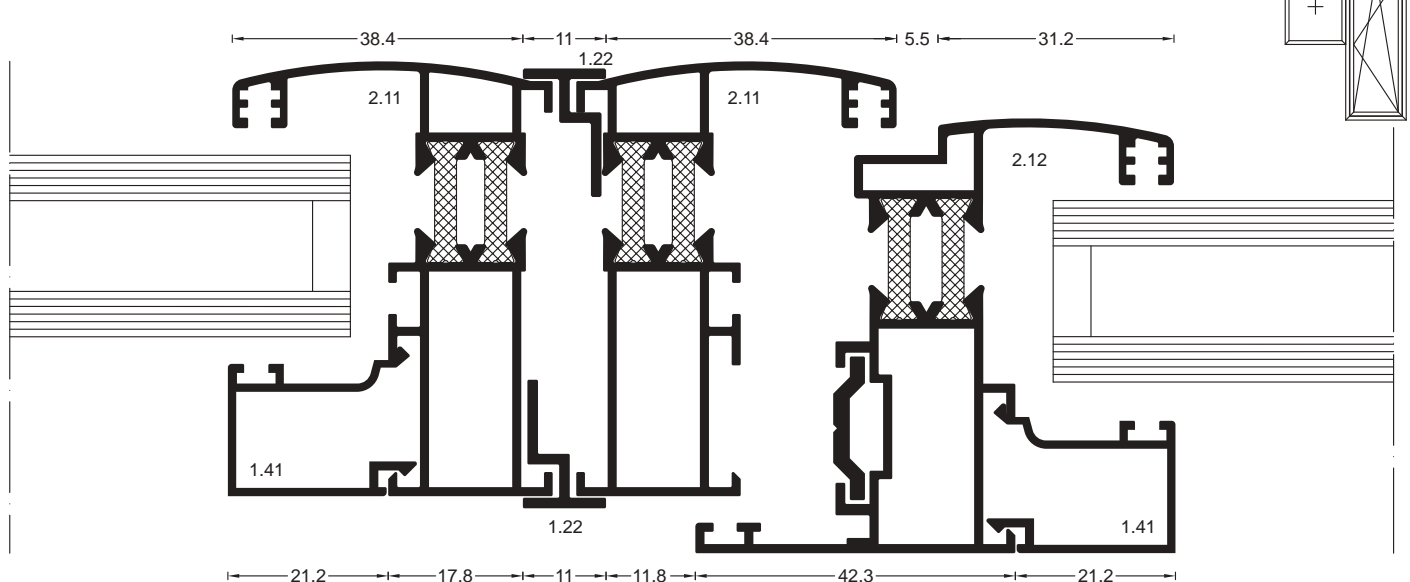



# MONTANA - SERIE SEMIROTUNDA, CU BARIERA TERMICA

## Sectiuni caracteristice pentru ferestre si usi

Panou ce face unghi la 90° intre o fereastră oscilo-batanta si una fixa.

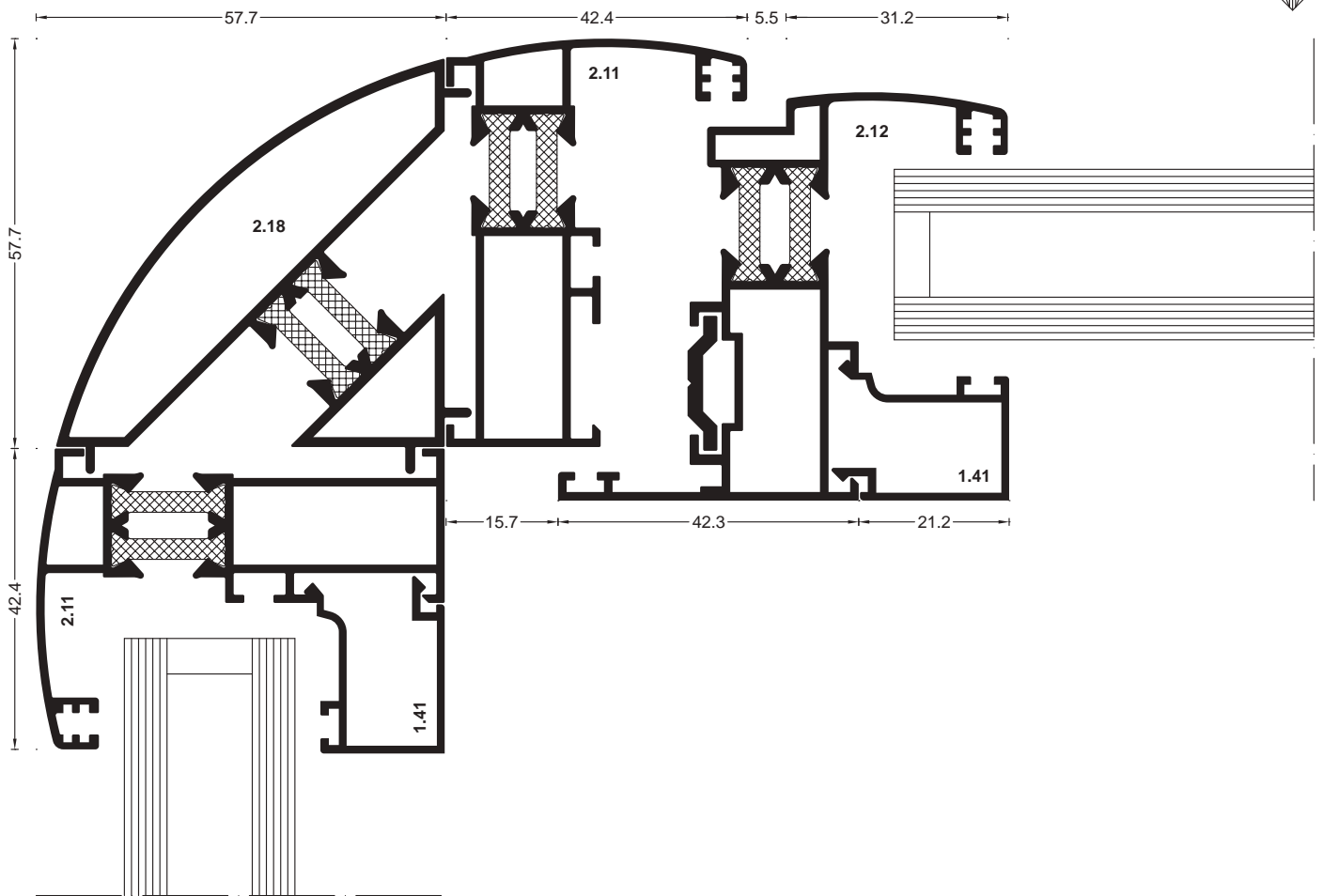

Usa cu 1 canat, deschidere inspre interior.

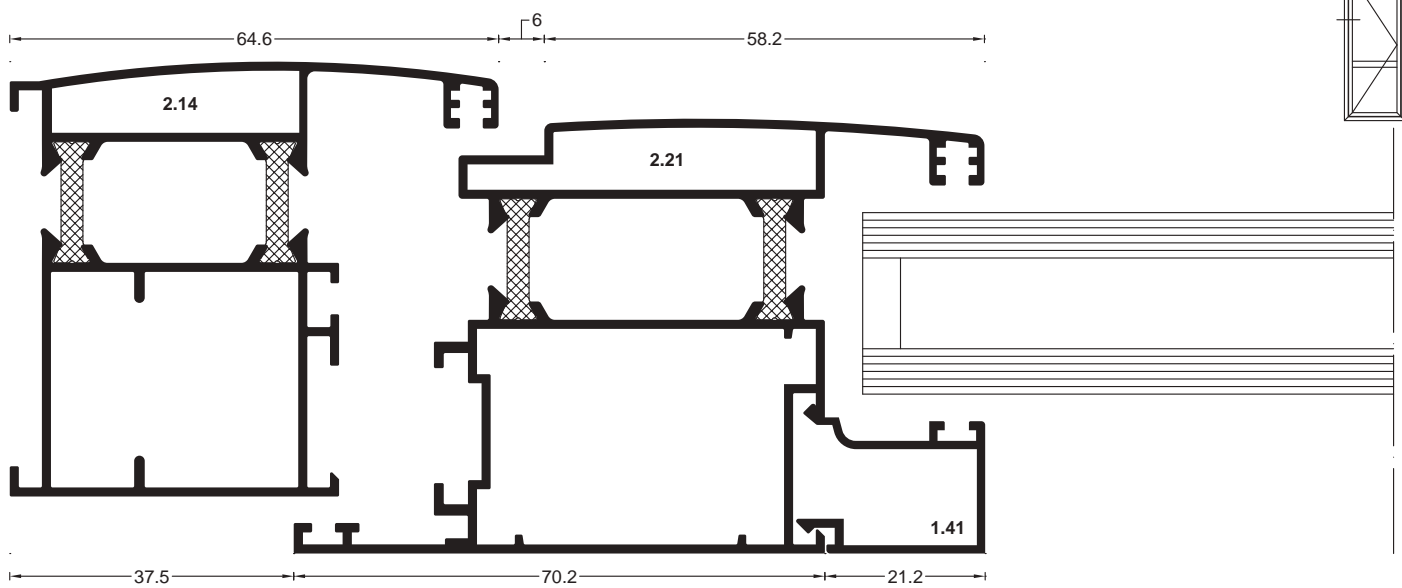



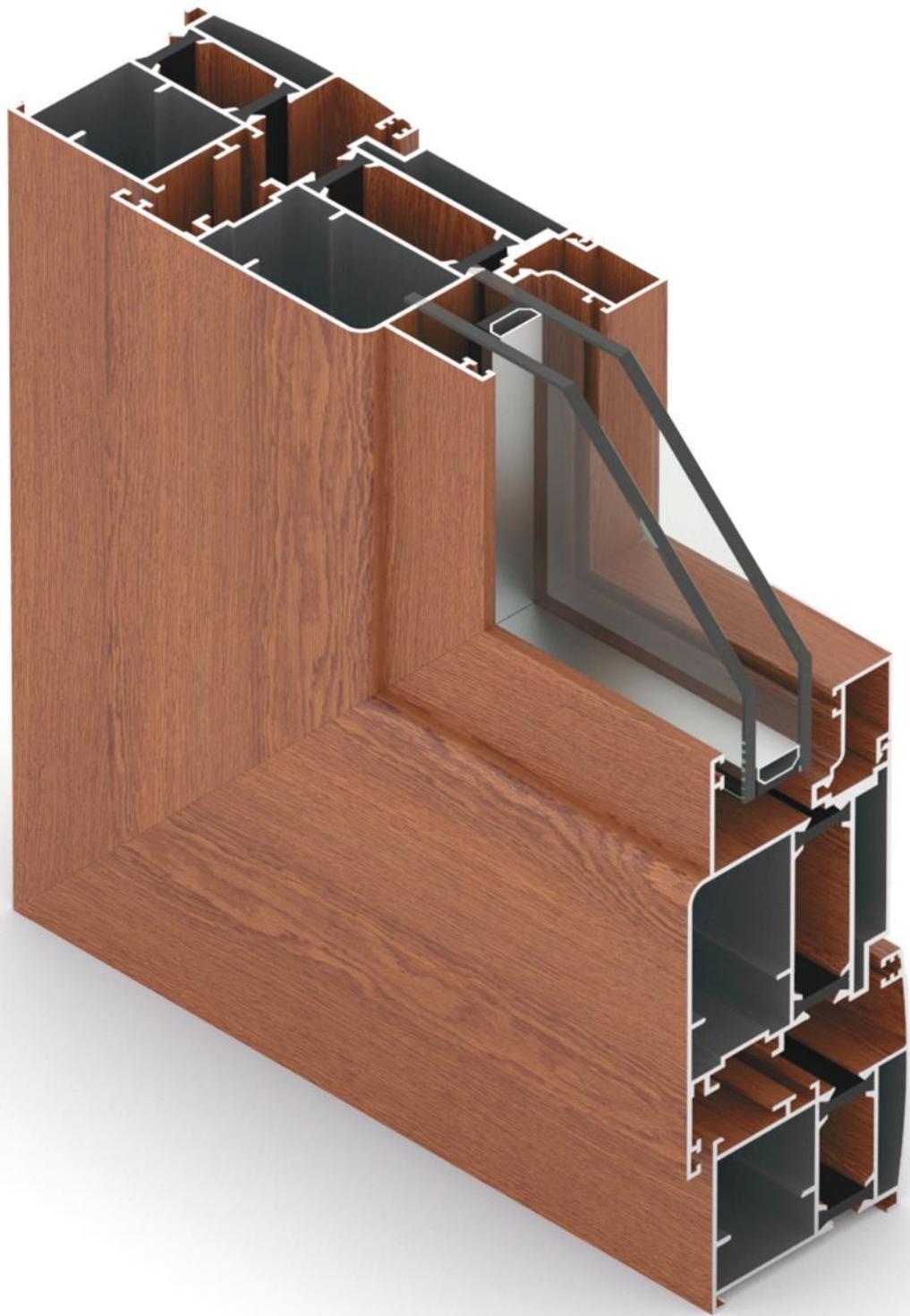



**SC ALPROF SA**

J/13/1252/1997  
RO 9558826

Str. IC Bratianu 6,  
Lumina, Constanta, 907175

Tel. 0241 255 696  
Fax. 0241 255 336

Mail: [office@alprof.ro](mailto:office@alprof.ro)  
Web: [www.alprof.ro](http://www.alprof.ro)